

AOD AL-H series LED High Mast Light, made by integrating the LED light source and the case into one piece, has many advantages, such as good heat dissipation, light weight, high brightness and far range of light projection, etc. In addition, the dimension of AOD AL-H series LED High mast light is similar to conventional light, but the interface can be custom-made.

The case of AOD LED High Mast Light is adopted with high-grade magnesium-aluminum alloy. By the usage of high-pressure once forming technology, the intensity and thermal conductivity of the case are high. With natural convection heat dissipation technology, the heat dissipation capability of the light is improved a lot. The low temperature eutectic bonding of LED lamps assures perfect LED thermal management from chip to external heating sinking mechanisms, the junction temperature is lower than 65°C, effectively controlling the light decay and prolonging the lifetime of the whole light more than 50,000 hrs. The high brightness LEDs are used to make AOD LED High Mast Light which ensure the luminaire efficacy is up to 130lm/w. The usage of second light distribution technology reduces the light loss and improves the utilization rate of light up to 90%. The optional multiply light distribution assures the LED high mast light can be applied for various places. The unique LED lamp protection technology assures the whole light normally works in case single LED lamp is broken.



The high reliable and intelligent driver with high power efficiency and professional heat sink design assures the working temperature of the electronic components is not higher than 60°C, and the lifetime of driver is more than 50,000 hrs. The wide-range power supply voltage assures the universality of AOD LED High Mast Light. The proprietary technology of constant current control enhances the reliability and stability of resistance. Meanwhile, such electronic driver design also provides several flexible and advanced control functions such as timer control, temperature control, photo sensor control, acoustic sensor control and internet control etc.

With excellent illumination and obviously energy-saving ability, AOD LED High Mast Light can replace the conventional high pole light from 400W to 1000W, which can be applicable for illumination of city squares, automobile stations, dock and port, goods yards, stadium, flyovers, etc.

With excellent illumination and obviously energy-saving ability, AOD LED High Mast Light can replace the conventional high pole light from 400W to 1000W, which can be applicable for illumination of city squares, automobile stations, dock and port, goods yards, stadium, flyovers, etc.

### LED High Mast Light power series

Part No.	Rated Wattage	Working Voltage	Working Frequency	Net Weight
AL-H15	150W	AC110/220V	50/60Hz	16kg
AL-H20	200W	AC 110/220V	50/60Hz	17kg
AL-H30	300W	AC 110/220V	50/60Hz	19kg
AL-H40	400W	AC 110/220V	50/60Hz	21kg

**Note:** Besides above standard power series, custom-made products are available also.

For more product details, please visit us at: [www.aodevices.com](http://www.aodevices.com)



AL-H20 Parameter

Items	Symbol	Min.	Typical	Max.	Conditions	Notes
Working Voltage (V)	Vin	175	220	265		
Working Frequency (Hz)	f	47	50	63		
Rated Wattage (W)	P	185	300	315	AC220V, 25°C	
Power Factor	PF	0.90	0.95	0.98	AC220V, 25°C	
Luminous Flux (lm)	Φ		27000			
Start Time (ms)				2000	AC220V, 25°C	
Color Temperature (K)	CCT	3500	-	6500		Optional <sup>1</sup>
Beam Angle(°)	Angle	15、30、45、60				
Light Distribution		single、mixed、polarized				
Working Temperature(°C)	Temp	-20		45	AC220V	
Adaptive Humidity (%)	RH			90		
Lifetime (hrs)	MTTF		50000		AC220V, 25°C	Influenced by ambient conditions
Net Weight (kg)	weight		19			Not including the package
LED IP Class	IP Class	IP65				

Note: 1、AOD Standard Color Temperature:

3500±200K、4000±250K、4500±250K、5000±300K、5700±350K、6500±500K

Luminous Flux Maintenance Chart

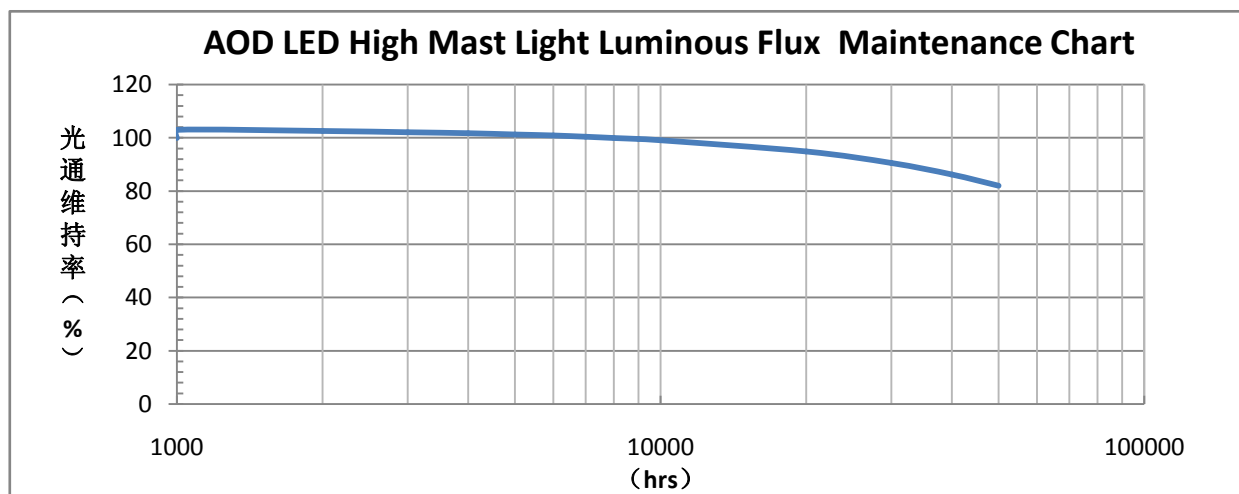

Remarks: This chart reflects the light decay trend of AOD LED High Mast Light according to the data tested by accelerated aging equipment in laboratory. We can see after 50,000 hrs lighting, the light decay is less than 20%.

**AL-H30 Structural Specification**

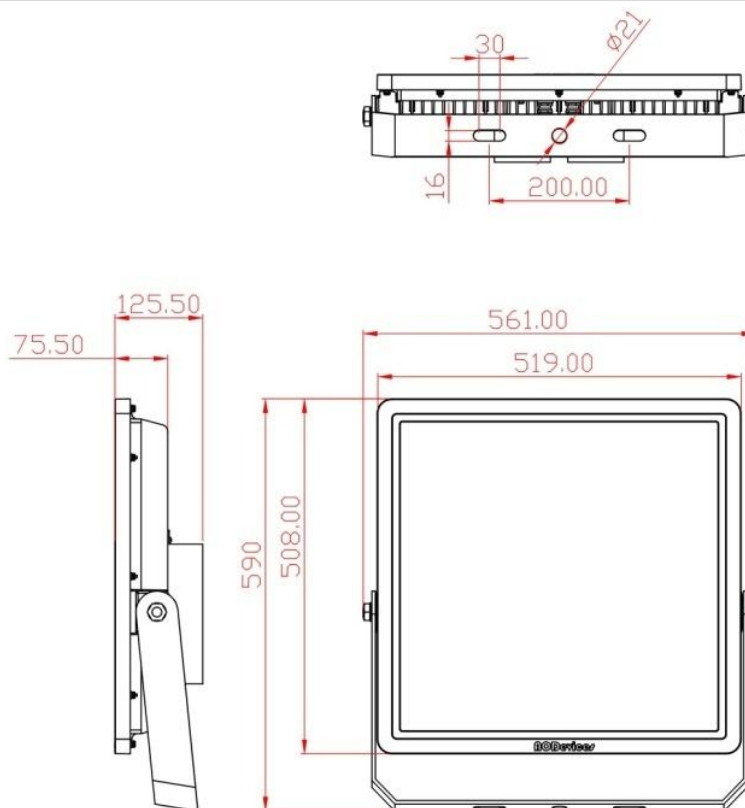

**Note:** The bracket in this picture is AOD'S standard model. If you have any particular requirements on the bracket, please contact our sales for custom- made.

**Packing Information**

The Packing dimension is showed on the right.

AOD LOGO, company name (in Chinese and English version), address and contact information of Advanced Optronic Devices (China) Co., Ltd are printed on the carton as well as the marks of transportation and storage requirements.



Each carton contains one piece of the said light printed on the carton surface, M16×40 outer hex bolts and the matched nuts, two pieces saw-tooth gaskets, two pieces flat pads, one product specification and one manual. Please inspect the products whether it is in perfect order, and check whether the documents and accessories are completely ready when you open the package.

### Adjustment Illustration of Installation Angle

There are two dials on each side of AOD LED High Mast Light with angle range from +90° to -90° . The degree between two graduations is 15° . The installation and using angle can be adjusted by operation the dial and the director needle within the range.

Firstly, please fix the bracket with the light by M16×40 bolts. In this step, please do not fasten the bolts to ensure the bracket can be rotated. Secondly, fasten the light to suitable position by M16 with torque 114Nm. At last, adjust the light to the expected angle, and tighten M16×16 bolts with torque 114Nm.

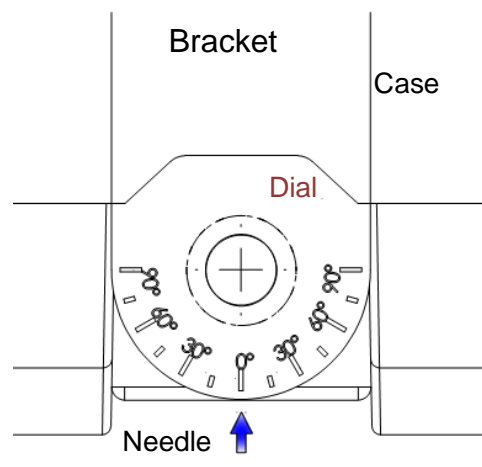



The outer hex spanner for M16 should be prepared before installation. When necessary, please also prepare the bush for M16.

### Wiring Instruction

Tri-core shield sleeve wire with standard 60245 IEC57(YZW) 3\*1.0mm<sup>2</sup> and OD Φ8~10mm is adopted, the red (or brown) wire of which connects the live wire, the blue one connects the neutral wire and the yellow-green one connects the ground wire. Insulation and waterproof treatment must be done at the joint of wires after the electrical connecting. Assuring the LED High Mast Light works under the rated voltage, otherwise the non-restorable damage will be made once the supply voltage is beyond the working voltage range.

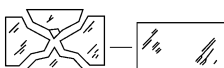
### Nameplate Diagram

 <b>LED高杆灯30°</b> A3044000010 中微光电子	
产品型号: AL-H40 额定电压: 220V~ 50/60Hz 额定电流: 1.91A@220V~ 额定功率: 400W 额定相关色温: 5700K	 防护等级: IP65 功率因数: 0.95 额定光通量: 32000lm
中微光电子（潍坊）有限公司 电话: (0536) 2221111	 



Note:

1. The ground wire must be safely earthed to guarantee the reliability!
2. The joint of wires must be covered with insulating tape and be waterproof!
3. Screws must be installed firmly to avoid the light drifting!
4. The supply voltage must not be beyond AC175V~265v, otherwise the impossibly repaired damage will be caused.
5. The light is connected in "Z" shape. The light should be scraped immediately if the external soft cables or soft wires damaged for they could not be replaced.
6. Please replace the shield if it is broken by thick 5mm tempered glass which is CCC certificated.



### After Sales Services

If you have any questions or problems in the process of unpacking, installation and use, please contact our Customer Service Department. We will respond within 2 hours, and if necessary, we will promptly send our maintenance professionals to reach your site as quickly as possible to solve your trouble and restore to the normal working condition.

AOD takes guarantee responsibility unless otherwise specified in the following circumstances:

- ✧ The breakdown or the damage is caused by incorrect installation, failure operation or use under the Not-specified working conditions.
- ✧ The damage is caused by accident, abuse or misuse. The breakdown or the damage is caused by customers' unsuitable safekeeping or transportation.
- ✧ The breakdown or the damage is caused by customers' disassembly or change the spare parts to which are not approved by AOD.
- ✧ The breakdown or the damage is caused by man-made or natural disaster.

**Customer Service Center: +86-536-2221111**

AOD will constantly improve our production performance and insist on innovation. The information contained in this document is the lately data at the deadline for edition and subject to change without notice.

AOD reserves the right to the interpretation of this document. The pictures shown here is indicative only. If there is inconsistency between the pictures and the actual product, the actual product shall govern.



Update Information

Edition	Date	Updated Description		Note
		Before	After	
3.0	2011-06-20	The 3 <sup>rd</sup> generation High Pole Light new issue		